

MUR1060 ULTRAFAST RECTIFIER

Applications:

- Switching Power Supply
- Power Switching Circuits
- General Purpose

Features:

- Ultra-Fast Switching
- High Current Capability
- Low Reverse Leakage Current
- High Surge Current Capability
- Plastic Material has UL Flammability Classification 94V-0
- This is a Pb - Free Device
- All SMC parts are traceable to the wafer lot
- Additional testing can be offered upon request

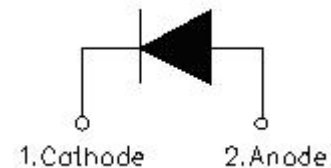

Mechanical Dimensions: In mm

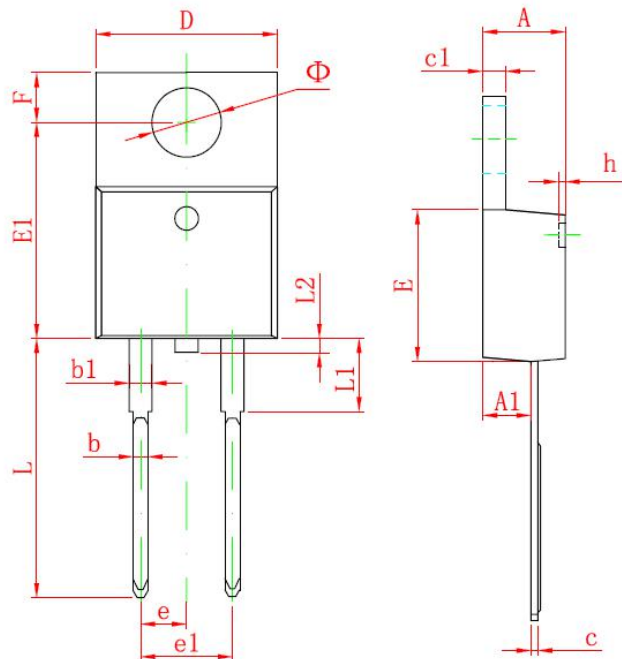

Symbol	Dimensions In Millimeters	
	Min	Max
A	4.470	4.670
A1	2.520	2.820
b	0.710	0.910
b1	1.170	1.370
c	0.310	0.530
c1	1.170	1.370
D	10.010	10.310
E	8.500	8.900
E1	12.060	12.460
e	2.540 TYP	
e1	4.980	5.180
F	2.590	2.890
h	0.000	0.300
L	13.400	13.800
L1	3.560	3.960
L2		1.000
φ	3.735	3.935

OPTION 1(CJ)

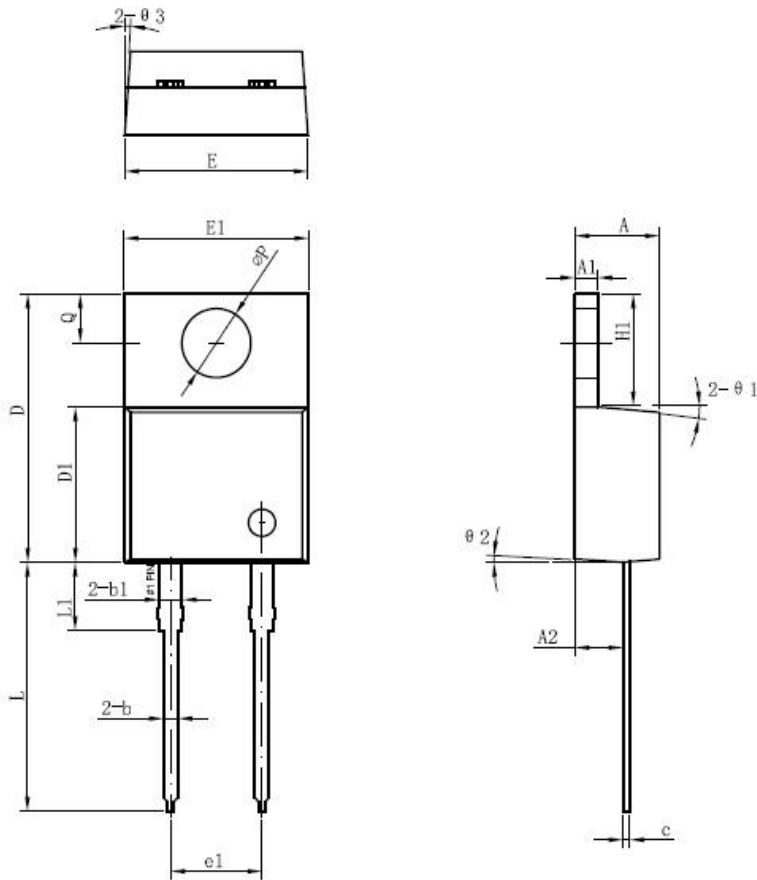

Symbol	Dimensions in millimeters		
	Min.	Typical	Max.
A	4.55	4.70	4.85
A1	1.17	1.27	1.37
A2	2.59	2.69	2.89
b	0.71	0.81	0.96
b1		1.27	
c	0.36	0.38	0.61
D	14.64	14.94	15.24
D1	8.55	8.07	8.85
E	10.01	10.16	10.31
E1	9.98	10.18	10.38
e1		5.08	
H1	6.04	6.24	6.44
L	13.00	13.86	14.08
L1		3.80	
ΦP	3.74	3.84	4.04
Q	2.54	2.74	2.94
$\theta 1$		5°	
$\theta 2$		4°	
$\theta 3$		4°	

OPTION 2(HD)

TO-220AC

Marking Diagram:

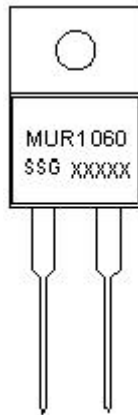

Where XXXXX is YYWWL

MUR = Device Type
 10 = Forward Current (10A)
 60 = Reverse Voltage (600V)
 SSG = SSG
 YY = Year
 WW = Week
 L = Lot Number

Cautions: Molding resin
 Epoxy resin UL:94V-0

Ordering Information:

Device	Package	Shipping
MUR1060	TO-220AC (Pb-Free)	50pcs / tube

For information on tape and reel specifications, including part orientation and tape sizes, please refer to our Tape and Reel Packaging Specification.

Maximum Ratings:

Characteristics	Symbol	Condition	Max.	Units
Peak Repetitive Reverse Voltage Working Peak Reverse Voltage DC Blocking Voltage	V_{RRM} V_{RWM} V_R	-	600	V
Average Forward Current	$I_{F(AV)}$	50% duty cycle @TC =100°C rectangular wave form	10	A
Peak One Cycle Non-Repetitive Surge Current	I_{FSM}	8.3 ms, half Sine pulse	125	A

Electrical Characteristics:

Characteristics	Symbol	Condition	Max.	Units
Forward Voltage Drop	V _{F1}	@ 10A, Pulse, T _J = 25°C	2.2	V
	V _{F2}	@ 10 A, Pulse, T _J = 100°C	2.0	V
Reverse Current	I _{R1}	@V _R = rated VR T _J = 25°C	5	μA
	I _{R2}	@V _R = rated VR T _J = 100°C	50	μA
Reverse Recovery Time	t _{rr}	I _F =10A, di/dt=50A/μs, 25°C	50	ns

* Pulse Width < 300μs, Duty Cycle <2%

Measured lead to lead 5 mm from package body

Thermal-Mechanical Specifications:

Characteristics	Symbol	Condition	Specification	Units
Junction Temperature	T _J	-	-55 to +150	°C
Storage Temperature	T _{stg}	-	-55 to +150	°C
Typical Thermal Resistance Junction to Case	R _{θJC}	DC operation	4	°C/W
Approximate Weight	wt	-	1.6	g
Case Style	TO-220AC			

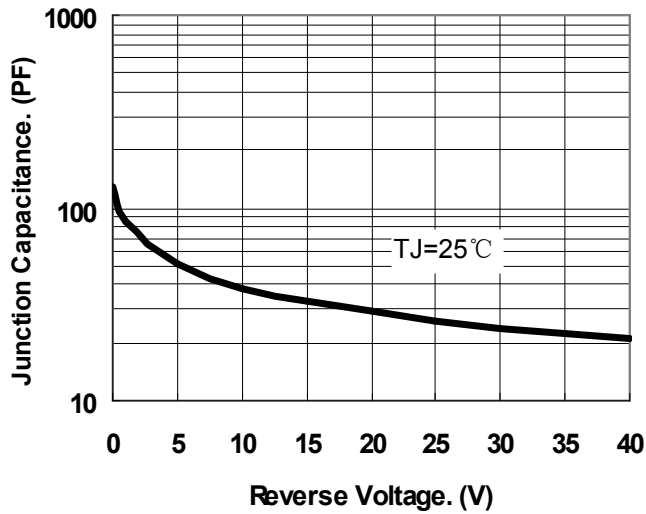

Fig.1-Typical Junction Capacitance

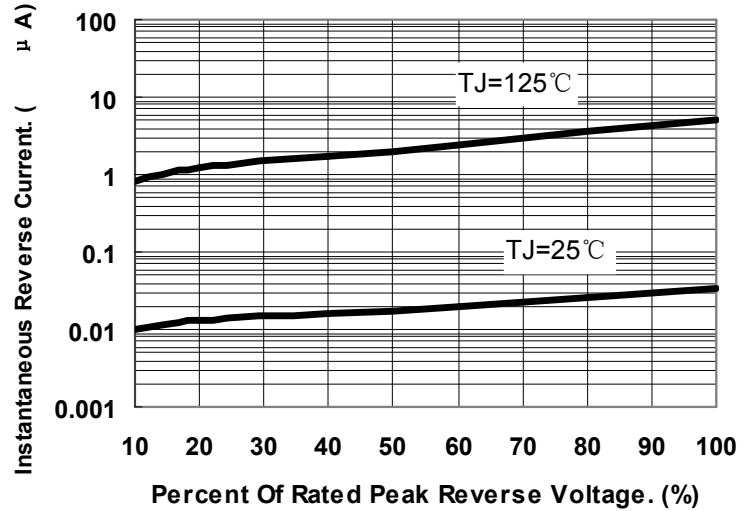

Fig.2-Typical Reverse Characteristics

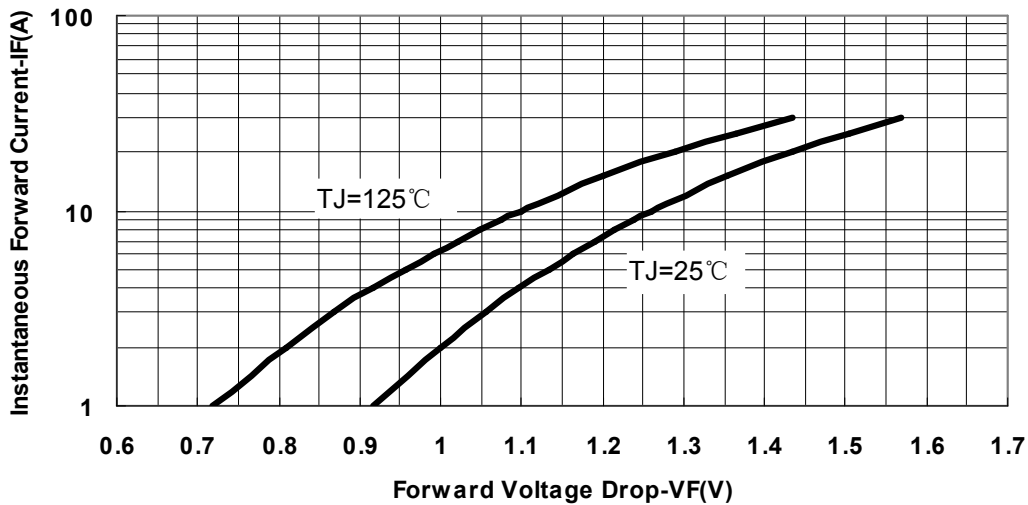

Fig.3-Typical Forward Voltage Drop Characteristics

DISCLAIMER:

- 1- The information given herein, including the specifications and dimensions, is subject to change without prior notice to improve product characteristics. Before ordering, purchasers are advised to contact the SMC - Sangdest Microelectronics (Nanjing) Co., Ltd sales department for the latest version of the datasheet(s).
- 2- In cases where extremely high reliability is required (such as use in nuclear power control, aerospace and aviation, traffic equipment, medical equipment, and safety equipment), safety should be ensured by using semiconductor devices that feature assured safety or by means of users' fail-safe precautions or other arrangement.
- 3- In no event shall SMC - Sangdest Microelectronics (Nanjing) Co., Ltd be liable for any damages that may result from an accident or any other cause during operation of the user's units according to the datasheet(s). SMC - Sangdest Microelectronics (Nanjing) Co., Ltd assumes no responsibility for any intellectual property claims or any other problems that may result from applications of information, products or circuits described in the datasheets.
- 4- In no event shall SMC - Sangdest Microelectronics (Nanjing) Co., Ltd be liable for any failure in a semiconductor device or any secondary damage resulting from use at a value exceeding the absolute maximum rating.
- 5- No license is granted by the datasheet(s) under any patents or other rights of any third party or SMC - Sangdest Microelectronics (Nanjing) Co., Ltd.
- 6- The datasheet(s) may not be reproduced or duplicated, in any form, in whole or part, without the expressed written permission of SMC - Sangdest Microelectronics (Nanjing) Co., Ltd.
- 7- The products (technologies) described in the datasheet(s) are not to be provided to any party whose purpose in their application will hinder maintenance of international peace and safety nor are they to be applied to that purpose by their direct purchasers or any third party. When exporting these products (technologies), the necessary procedures are to be taken in accordance with related laws and regulations..