

ST12100S SCHOTTKY RECTIFIER

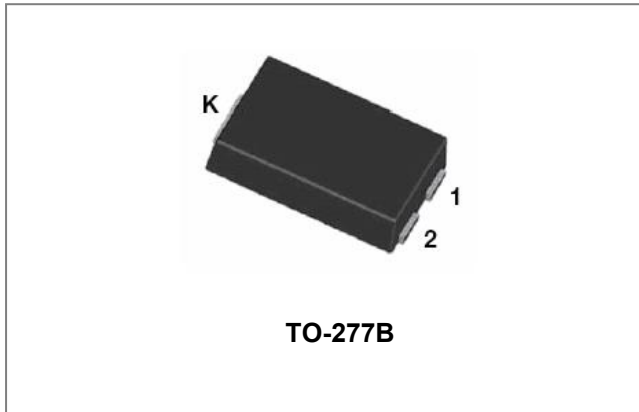

Features

- 150°C T_J operation
- Low forward voltage drop
- High purity, high temperature epoxy encapsulation for enhanced mechanical strength and moisture resistance
- High frequency operation
- Guard ring for enhanced ruggedness and long term reliability
- Trench MOS Schottky technology
- “-A” is an AEC-Q101 qualified device
- This is a Pb – Free Device
- All SMC parts are traceable to the wafer lot
- Additional testing can be offered upon request

Circuit Diagram

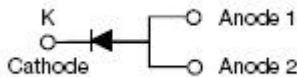

Applications

- Switching power supply
- Converters
- Free-Wheeling diodes
- Reverse battery protection

Maximum Ratings:

Characteristics	Symbol	Condition	Max.	Units
Peak Repetitive Reverse Voltage	V _{RRM}	-	100	V
Working Peak Reverse Voltage	V _{RWM}			
DC Blocking Voltage	V _R			
Average Rectified Forward Current	I _{F(AV)}	50% duty cycle @T _L =125°C, rectangular wave form	12	A
Peak One Cycle Non-Repetitive Surge Current	I _{FSM}	8.3ms, Half Sine pulse, T _J = 25 °C	200	A

Electrical Characteristics:

Characteristics	Symbol	Condition	Typ.	Max.	Units
Forward Voltage Drop*	V _{F1}	@ 5A, Pulse, T _J = 25 °C	0.50	-	V
		@ 12A, Pulse, T _J = 25 °C	0.68	0.70	
	V _{F2}	@ 5A, Pulse, T _J = 125 °C	0.47	-	V
		@ 12A, Pulse, T _J = 125 °C	0.61	0.64	
Reverse Current*	I _{R1}	@V _R = rated V _R T _J = 25 °C	0.02	0.3	mA
Reverse Current*	I _{R2}	@V _R = rated V _R T _J = 125 °C	28	50	mA
Junction Capacitance	C _T	@V _R = 5V, T _C = 25 °C f _{SIG} = 1MHz	600	-	pF

* Pulse width < 300 μs, duty cycle < 2%

- China - Germany - Korea - Singapore - United States •
- <http://www.smc-diodes.com> - sales@smc-diodes.com •

Thermal-Mechanical Specifications:

Characteristics	Symbol	Condition	Specification	Units
Junction Temperature	T_J	-	-55 to +150	°C
Storage Temperature	T_{stg}	-	-55 to +150	°C
Typical Thermal Resistance Junction to Ambient (NOTE1)	$R_{\theta JA}$	DC operation	75	°C/W
Typical Thermal Resistance Junction to Lead (NOTE1)	$R_{\theta JL}$	DC operation	4	°C/W
Approximate Weight	wt	-	0.08	g

NOTE: 1. Units mounted on P.C.B., 0.5 x 0.5" (30 x 30mm) copper pads.

Ratings and Characteristics Curves

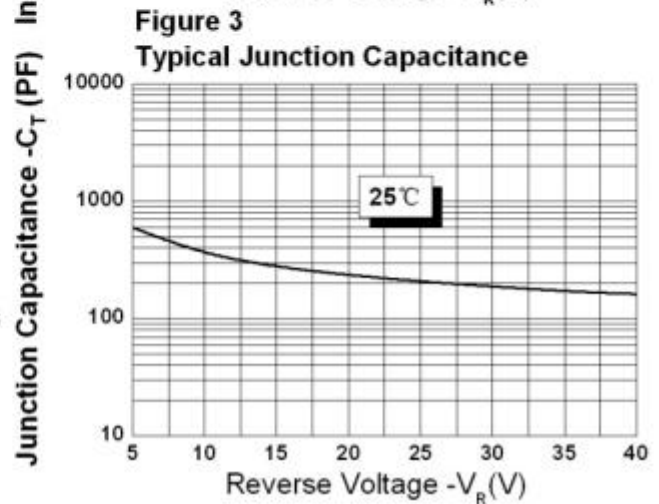
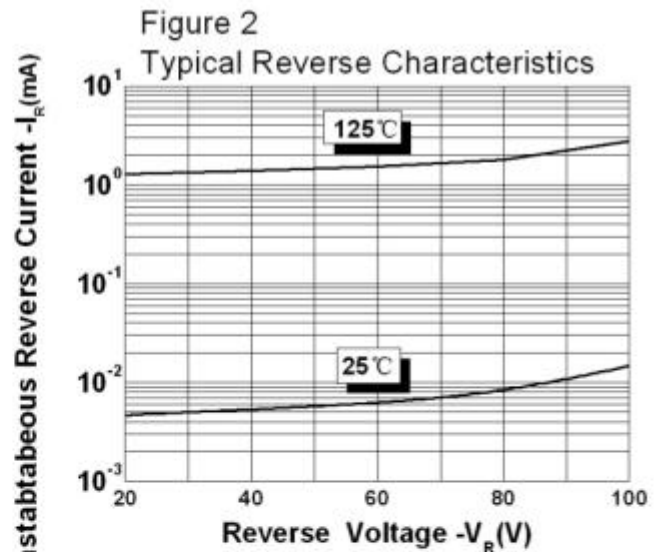
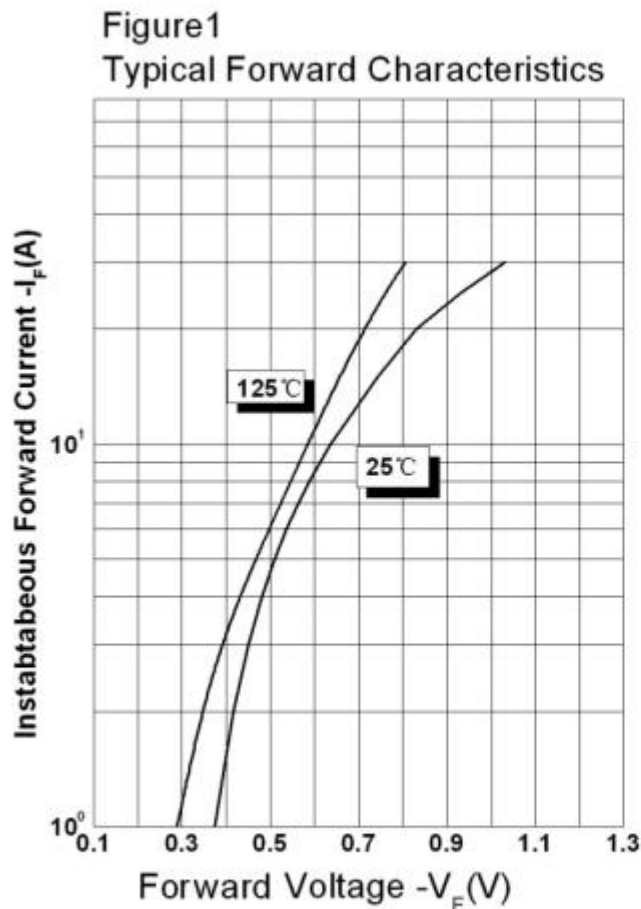

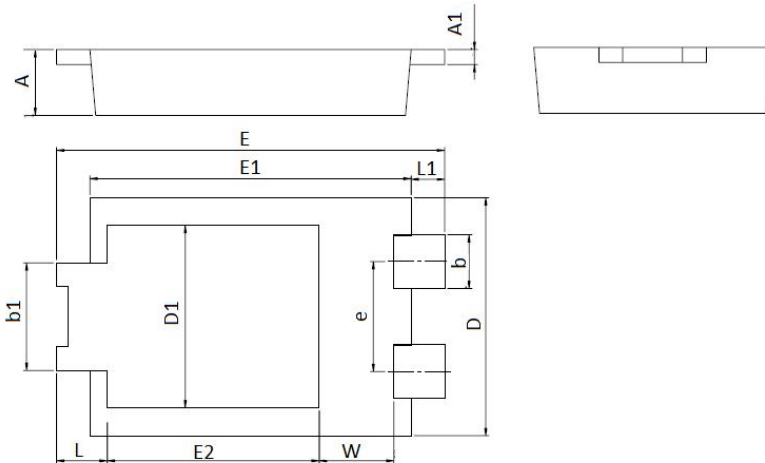
Mechanical Dimensions TO-277B

SYMBOL	Millimeters		Inches	
	Min.	Max.	Min.	Max.
A	0.95	1.25	0.037	0.049
A1	0.20	0.30	0.008	0.012
b	0.85	0.95	0.033	0.037
b1	1.70	1.90	0.067	0.075
D	3.88	4.08	0.153	0.161
D1	2.90	3.20	0.114	0.126
e	1.74	1.94	0.069	0.076
E	6.30	6.70	0.248	0.264
E1	5.28	5.48	0.208	0.216
E2	3.40	3.70	0.134	0.146
L	0.70	1.00	0.028	0.039
L1	0.41	0.71	0.016	0.028
W	1.10	1.40	0.043	0.055

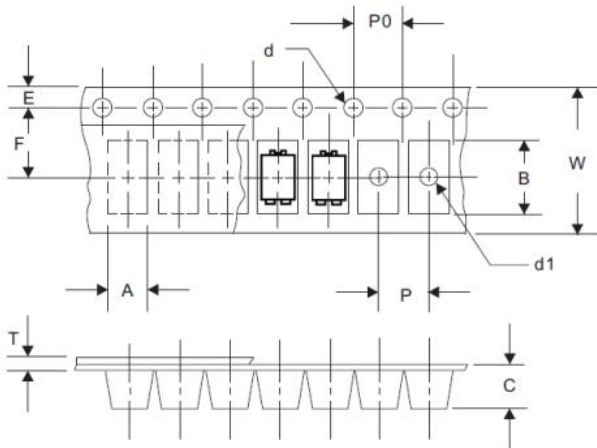
Carrier Tape Specification TO-277B

SYMBOL	Millimeters	
	Min.	Max.
A	4.28	4.48
B	6.80	7.10
C	1.30	1.50
d	1.40	1.60
d1	-	1.50
E	1.65	1.85
F	5.40	5.60
P	7.90	8.10
P0	3.90	4.10
T	0.24	0.44
W	11.70	12.30

Ordering Information

Device	Package	Shipping
ST12100S	TO-277B(Pb-Free)	5000pcs/ reel

For information on tape and reel specifications, including part orientation and tape sizes, please refer to our tape and reel packaging specification.

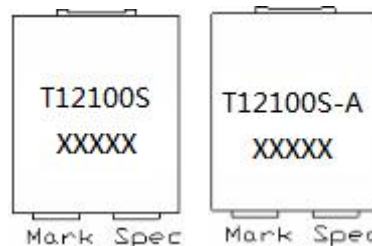
Marking Diagram

Where XXXXX is YYWWL

- T = Device Type
- 12 = Forward Current (12A)
- 100 = Reverse Voltage (100V)
- S = Package type
- A = AEC-Q101
- YY = Year
- WW = Week
- L = Lot Number

Cautions: Molding resin
Epoxy resin UL:94V-0

DISCLAIMER:

- 1- The information given herein, including the specifications and dimensions, is subject to change without prior notice to improve product characteristics. Before ordering, purchasers are advised to contact the SMC Diode Solutions sales department for the latest version of the datasheet(s).
- 2- In cases where extremely high reliability is required (such as use in nuclear power control, aerospace and aviation, traffic equipment, medical equipment, and safety equipment), safety should be ensured by using semiconductor devices that feature assured safety or by means of users' fail-safe precautions or other arrangement.
- 3- In no event shall SMC Diode Solutions be liable for any damages that may result from an accident or any other cause during operation of the user's units according to the datasheet(s). SMC Diode Solution assumes no responsibility for any intellectual property claims or any other problems that may result from applications of information, products or circuits described in the datasheets.
- 4- In no event shall SMC Diode Solutions be liable for any failure in a semiconductor device or any secondary damage resulting from use at a value exceeding the absolute maximum rating.
- 5- No license is granted by the datasheet(s) under any patents or other rights of any third party or SMC Diode Solutions.
- 6- The datasheet(s) may not be reproduced or duplicated, in any form, in whole or part, without the expressed written permission of SMC Diode Solutions.
- 7- The products (technologies) described in the datasheet(s) are not to be provided to any party whose purpose in their application will hinder maintenance of international peace and safety nor are they to be applied to that purpose by their direct purchasers or any third party. When exporting these products (technologies), the necessary procedures are to be taken in accordance with related laws and regulations..