

20SQ045 SCHOTTKY BARRIER RECTIFIER

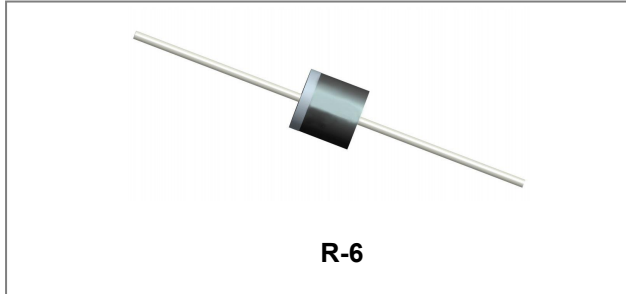

Features

- Super-high speed & low noise switching
- Low voltage drop
- Terminals finish: 100% Pure Tin
- This is a Pb – Free Device
- All SMC parts are traceable to the wafer lot
- Additional testing can be offered upon request

Circuit Diagram



Mechanical Data

- DC-DC converters
- AC adapter
- High frequency rectification circuit
- Bypass diodes

Maximum Ratings:

Characteristics	Symbol	Condition	Max.	Units
Peak Repetitive Reverse Voltage Working Peak Reverse Voltage DC Blocking Voltage	V_{RRM} V_{RWM} V_R	-	45	V
Average Rectified Forward Current	$I_{F(AV)}$	50% duty cycle @ $T_A=25^\circ\text{C}$, rectangular wave form	20	A
Peak One Cycle Non-Repetitive Surge Current	I_{FSM}	8.3 ms, half Sine pulse	350	A

Electrical Characteristics:

Characteristics	Symbol	Condition	Typ.	Max.	Units	
Peak Forward Voltage	V_{FM}	$I_{FM}=20.0\text{A}, T_a=25^\circ\text{C}$	0.48	0.55	V	
Peak Reverse Current	I_{RRM1}	$V_{RM}=V_{RRM}$	$T_a=25^\circ\text{C}$	0.07	0.5	mA
	I_{RRM2}		$T_a=100^\circ\text{C}$	-	50	
Thermal Resistance	$R_{\theta J-c}$	Between junction and case	3.0	-	$^\circ\text{C}/\text{W}$	
	$R_{\theta J-L}$	Between junction and lead	2.0	-		

Thermal-Mechanical Specifications:

Characteristics	Symbol	Condition	Specification	Units
Junction Temperature at reduced reverse voltage at reduced reverse voltage in DC forward mode	T_J	$V_R \leq 80\% V_{RRM}$ $V_R \leq 50\% V_{RRM}$	-55 to +150 -55 to +180 -55 to +200	$^{\circ}\text{C}$
Storage Temperature	T_{stg}	-	-55 to +150	$^{\circ}\text{C}$
Approximate Weight	wt	-	2.24	g
Case Style		R-6		

Ratings and Characteristics Curves

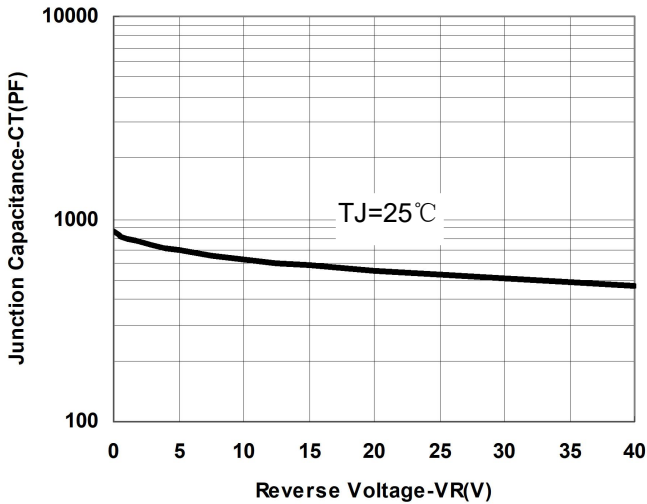

Fig.1-Typical Junction Capacitance

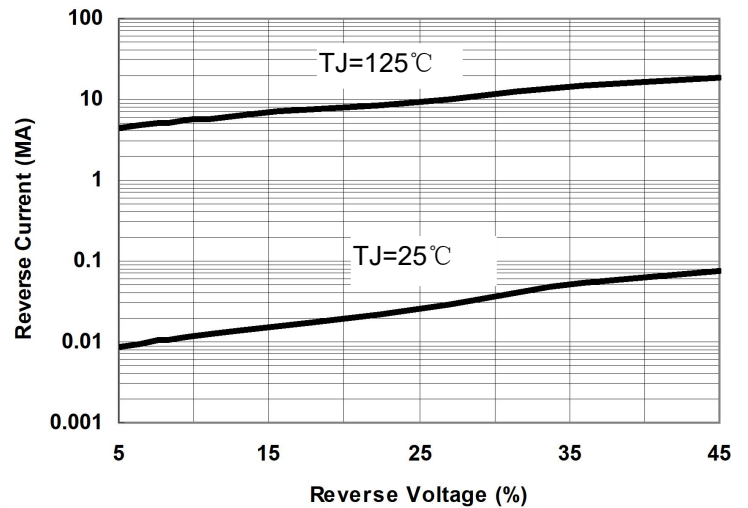

Fig.2-Typical Reverse Characteristics

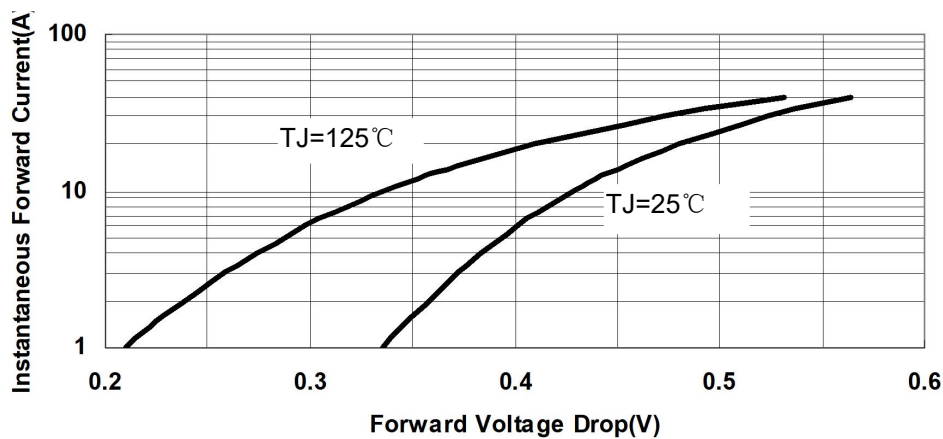
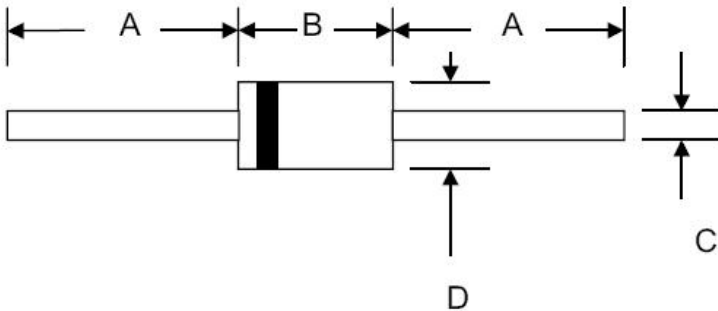

Fig.3-Typical Instantaneous Forward Voltage Characteristics

Mechanical Dimensions R-6



SYMBOL	Millimeters		Inches	
	Min.	Max.	Min.	Max.
A	25.4	-	1.000	-
B	8.60	9.10	0.340	0.360
C	1.2	1.3	0.048	0.052
D	8.60	9.10	0.340	0.360

Ordering Information

Device	Package	Shipping
20SQ045	R-6(Pb-Free)	500pcs / reel
20SQ045TA	R-6(Pb-Free)	450pcs / tape
20SQ045TR	R-6(Pb-Free)	500pcs / reel

For information on tape and reel specifications, including part orientation and tape sizes, please refer to our tape and reel packaging specification.

Marking Diagram

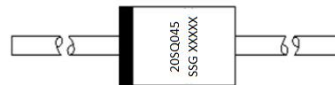

Where XXXXX is YYWWL

- 20 = Forward Current (20A)
- S = Package Type
- Q = Device Type
- 045 = Reverse Voltage (45V)
- SSG = SSG
- YY = Year
- WW = Week
- L = Lot Number

Carrier Tape Specification R-6

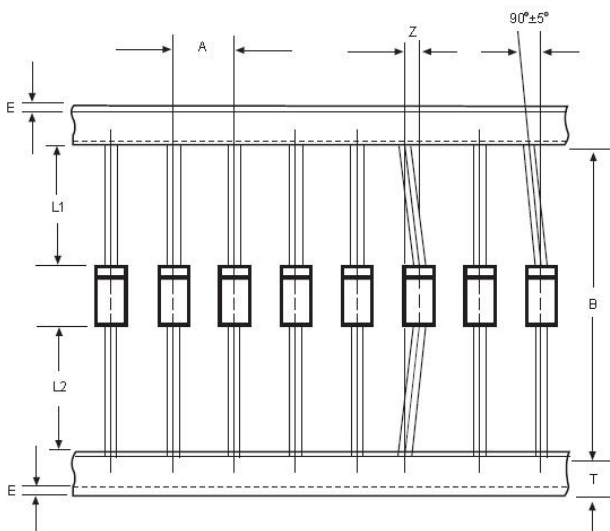

SYMBOL	Millimeters	
	Min.	Max.
A	9.50	10.50
B	50.9	53.9
Z	-	1.20
T	5.60	6.40
E	-	0.80
IL1-L2I	-	1.0

DISCLAIMER:

1- The information given herein, including the specifications and dimensions, is subject to change without prior notice to improve product characteristics. Before ordering, purchasers are advised to contact the SMC Diode Solutions sales department for the latest version of the datasheet(s).

2- In cases where extremely high reliability is required (such as use in nuclear power control, aerospace and aviation, traffic equipment, medical equipment, and safety equipment), safety should be ensured by using semiconductor devices that feature assured safety or by means of users' fail-safe precautions or other arrangement.

3- In no event shall SMC Diode Solutions be liable for any damages that may result from an accident or any other cause during operation of the user's units according to the datasheet(s). SMC Diode Solution assumes no responsibility for any intellectual property claims or any other problems that may result from applications of information, products or circuits described in the datasheets.

4- In no event shall SMC Diode Solutions be liable for any failure in a semiconductor device or any secondary damage resulting from use at a value exceeding the absolute maximum rating.

5- No license is granted by the datasheet(s) under any patents or other rights of any third party or SMC Diode Solutions.

6- The datasheet(s) may not be reproduced or duplicated, in any form, in whole or part, without the expressed written permission of SMC Diode Solutions.

7- The products (technologies) described in the datasheet(s) are not to be provided to any party whose purpose in their application will hinder maintenance of international peace and safety nor are they to be applied to that purpose by their direct purchasers or any third party. When exporting these products (technologies), the necessary procedures are to be taken in accordance with related laws and regulations..